

Silenziatore

modello
SFE

Livelli di rumore in dB 6 BAR
Noise level at 6 BAR

1/8	1/4	3/8	1/2	3/4	1
74	72	88	90	90	92

Livelli di rumore in dB 4 BAR
Noise level at 4 BAR

1/8	1/4	3/8	1/2	3/4	1
70	69	85	85	86	88

Filo in acciaio inox
Stainless steel wire
Fil acier inox
Inox stahldraht

Ottone
Brass
Laiton
Messing

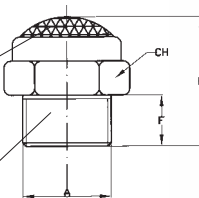

A	F	H	CH
1/8" BSP	6	15	13
1/4" BSP	7	18	16
3/8" BSP	8	20	19
1/2" BSP	10	22	24
3/4" BSP	10	26	30
1 BSP	12	28	36
M 5	4	8	8
1/8" FEM BSP	5	13	13

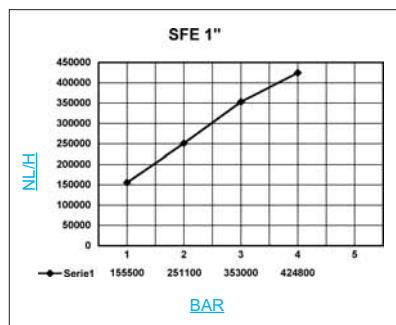
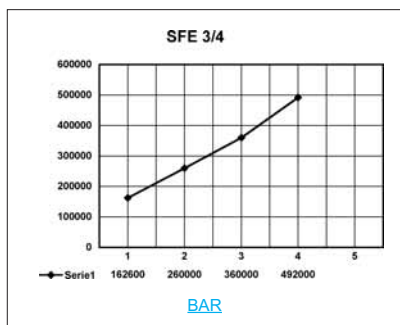
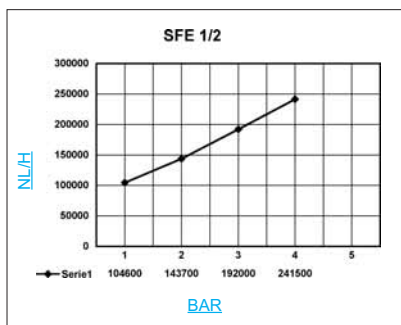
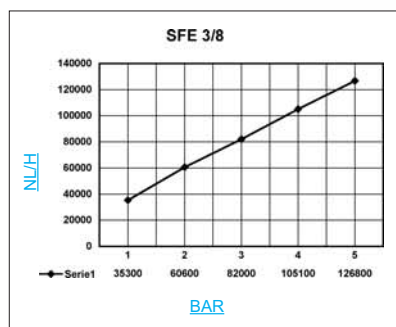
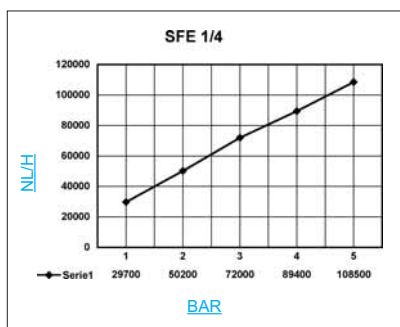
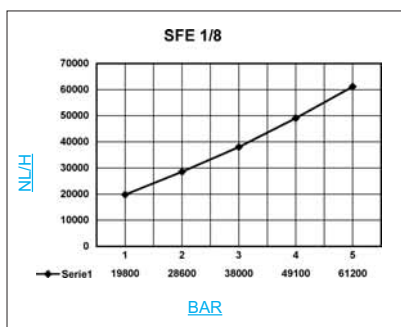

SILENZIATORI
AIR SILENCERS
SILENCIEUX
SCHALLDÄMPFER

COPOR



Silenziatore

modello
SFE X



Livelli di rumore in dB 6 BAR
Noise level at 6 BAR

1/8	1/4	3/8	1/2	3/4	1
74	72	88	90	90	92

Livelli di rumore in dB 4 BAR
Noise level at 4 BAR

1/8	1/4	3/8	1/2	3/4	1
70	69	85	85	86	88

Filo in acciaio inox
Stainless steel wire
Fil acier inox
Inox stahldraht

Acciaio inox
Stainless steel
Acier inox
Inox

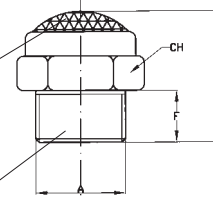

A	F	H	CH
1/8" BSP	6	15	13
1/4" BSP	7	18	16
3/8" BSP	8	20	19
1/2" BSP	10	22	24
3/4" BSP	10	26	30
1 BSP	12	28	36

SILENZIATORI
AIR SILENCERS
SILENCIEUX
SCHALLDÄMPFER

COPOR

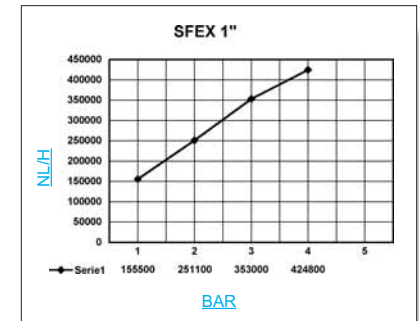
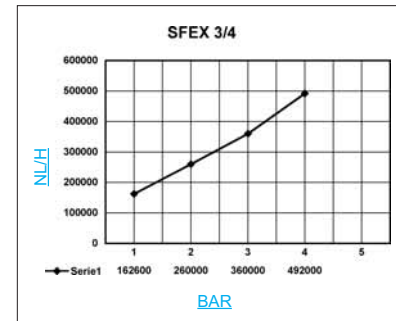
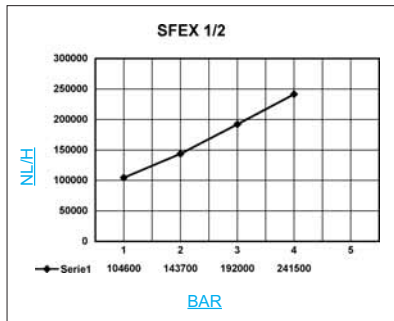
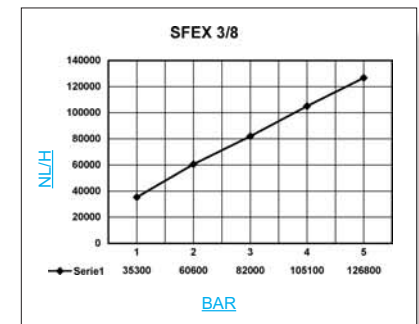
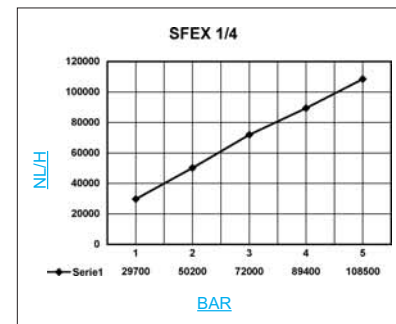
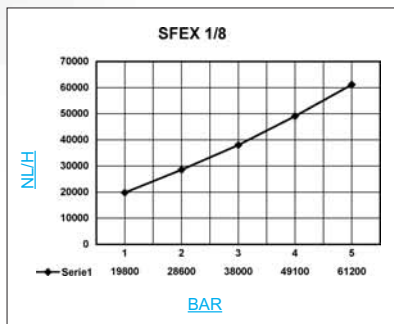

Silenziatore

modello
SFT

Livelli di rumore in dB 6 BAR
Noise level at 6 BAR

1/8	1/4	3/8	1/2	3/4	1
74	72	88	90	90	92

Livelli di rumore in dB 4 BAR
Noise level at 4 BAR

1/8	1/4	3/8	1/2	3/4	1
70	69	85	85	86	88

Filo in acciaio inox
Stainless steel wire
Fil acier inox
Inox stahldraht

Ottone
Brass
Laiton
Messing

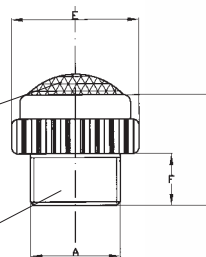

A	F	H	E
1/8" BSP	6	13	13
1/4" BSP	7	14	16
3/8" BSP	8	18	19
1/2" BSP	10	19	24
3/4" BSP	10	22	30
1 BSP	12	23	38
M 5	5	12	13
1/8" FEM BSP	7	14	12

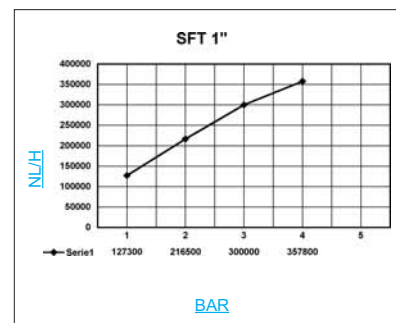
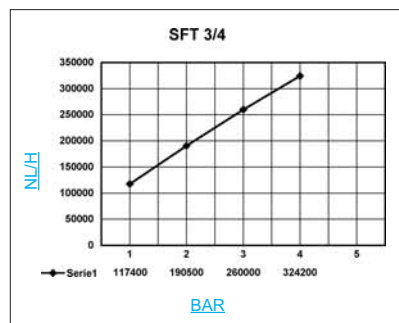
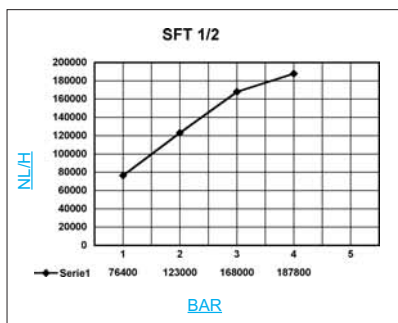
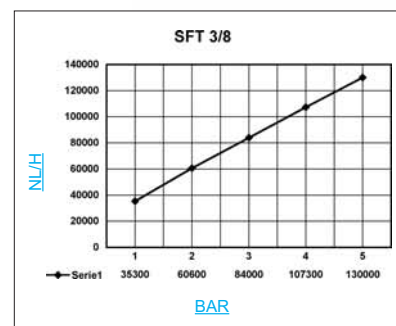
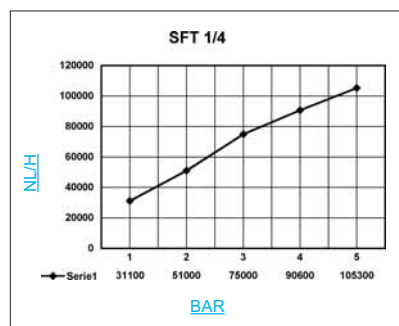
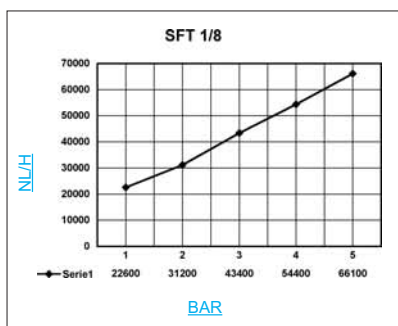

SILENZIATORI
AIR SILENCERS
SILENCIEUX
SCHALLDÄMPFER

COPOR





Livelli di rumore in dB 6 BAR
Noise level at 6 BAR

1/8	1/4	3/8	1/2	3/4	1
73	74	85	89	89	90

Livelli di rumore in dB 4 BAR
Noise level at 4 BAR

1/8	1/4	3/8	1/2	3/4	1
70	71	83	85	87	87

Bronzo sinterizzato
Sintered bronze
Bronze frittè
Sinterbronze

Ottone
Brass
Laiton
Messing

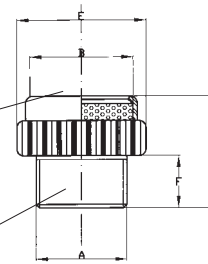

Silenziatore

modello
SBP

A	B	E	F	H
1/8" BSP	11	13	6	12
1/4" BSP	14	16	7	13
3/8" BSP	17	19	8	17
1/2" BSP	22	24	10	18
3/4" BSP	28	30	10	20
1 BSP	35	38	12	21
M5	11	13	5	11,5
1/8" FEM BSP	11	12	7	13

SILENZIATORI
AIR SILENCERS
SILENCIEUX
SCHALLDÄMPFER

COPOR

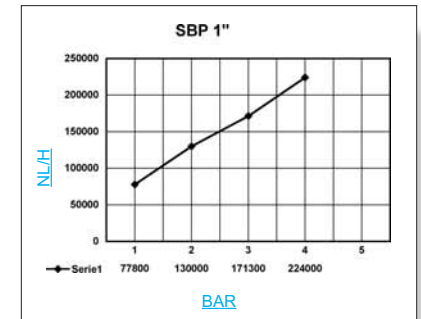
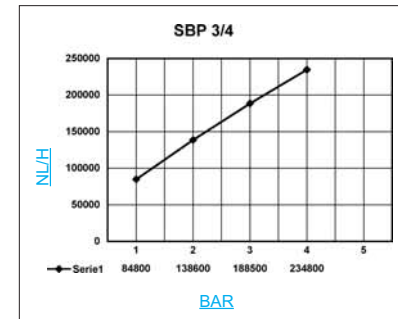
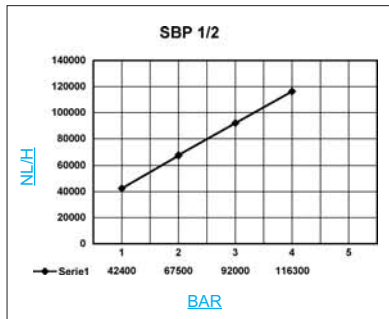
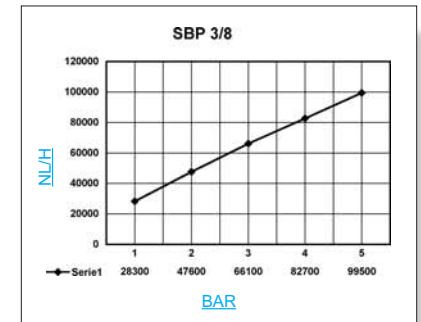
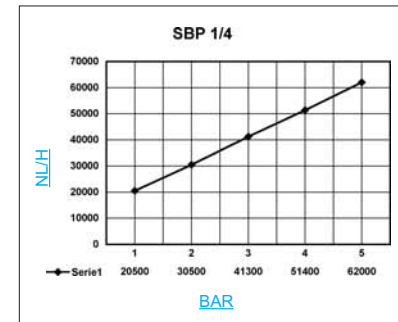
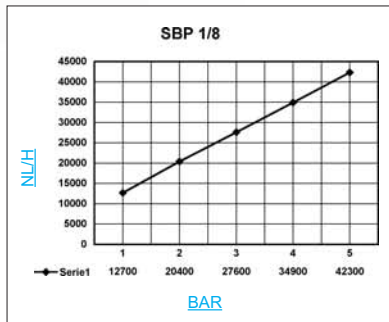

Silenziatore

modello
SEP

Livelli di rumore in dB 6 BAR
Noise level at 6 BAR

1/8	1/4	3/8	1/2	3/4	1
73	74	85	89	89	90

Livelli di rumore in dB 4 BAR
Noise level at 4 BAR

1/8	1/4	3/8	1/2	3/4	1
70	71	83	85	87	87

Bronzo sinterizzato
Sintered bronze
Bronze fritte
Sinterbronze

Ottone
Brass
Laiton
Messing

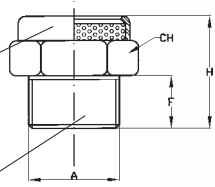

A	CH	F	H
1/8" BSP	13	6	13
1/4" BSP	16	7	16
3/8" BSP	19	8	16
1/2" BSP	24	10	18
3/4" BSP	30	10	19
1 BSP	36	10	20
M5	8	5	12
1/8" FEM BSP	13	5	12

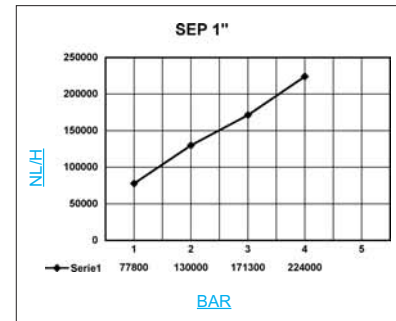
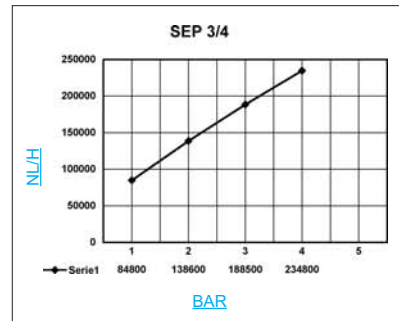
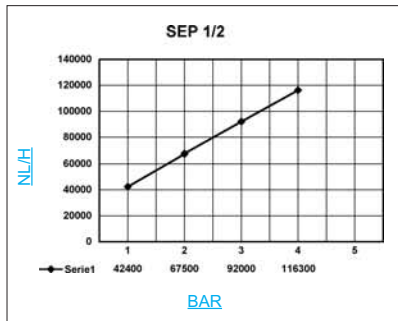
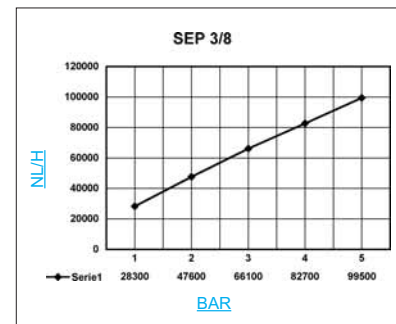
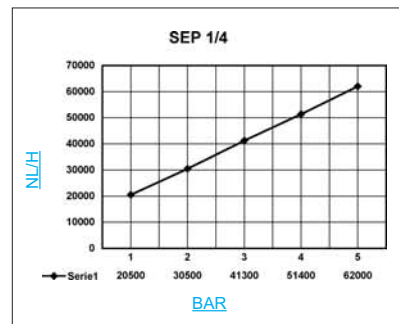
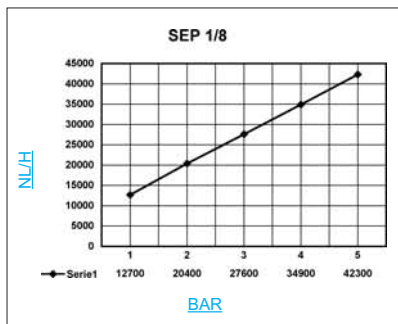

SILENZIATORI
AIR SILENCERS
SILENCIEUX
SCHALLDÄMPFER

COPOR





Livelli di rumore in dB 6 BAR
Noise level at 6 BAR

1/8	1/4	3/8	1/2	3/4	1
72	73	84	88	88	89

Livelli di rumore in dB 4 BAR
Noise level at 4 BAR

1/8	1/4	3/8	1/2	3/4	1
69	70	82	84	85	85

Bronzo sinterizzato
Sintered bronze
Bronze frittè
Sinterbronze

Ottone
Brass
Laiton
Messing

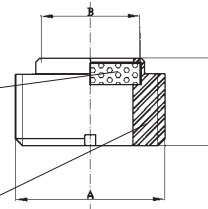

Silenziatore

modello
SP

A	B	H
1/8" BSP	6	5
1/4" BSP	8	6
3/8" BSP	10	7
1/2" BSP	15	8
3/4" BSP	20	9
1" BSP	26	10

SILENZIATORI
AIR SILENCERS
SILENCIEUX
SCHALLDÄMPFER

COPOR

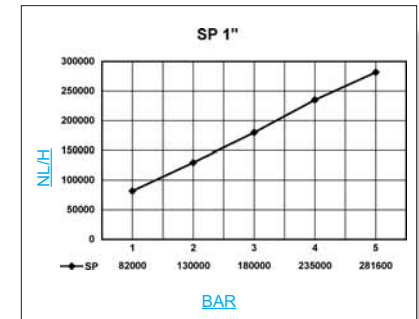
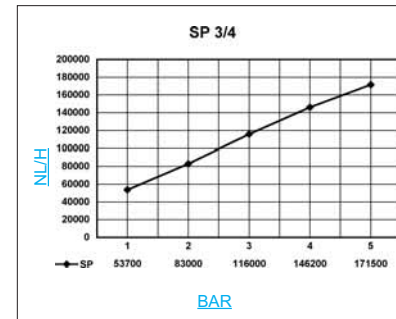
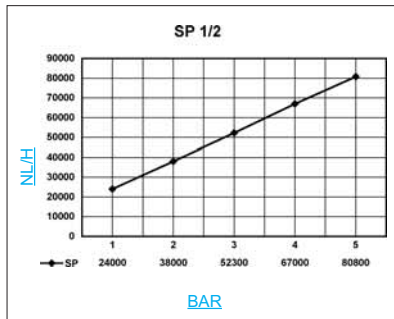
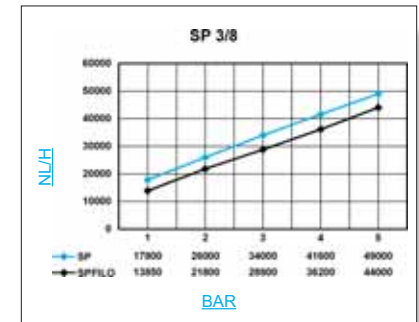
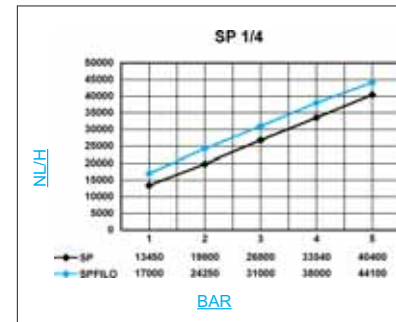
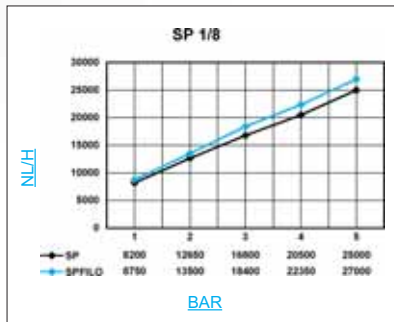

Silenziatore

modello
SEB

Livelli di rumore in dB 6 BAR
Noise level at 6 BAR

1/8	1/4	3/8	1/2	3/4	1
79	78	82	85	94	95

Livelli di rumore in dB 4 BAR
Noise level at 4 BAR

1/8	1/4	3/8	1/2	3/4	1
76	75	81	84	90	92

Bronzo sinterizzato
Sintered bronze
Bronze fritte
Sinterbronze

Acciaio ramato
Copper plated
Steel

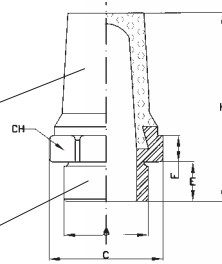

A	C	CH	E	F	H
1/8" BSP	12,6	12	4,5	3,8	20,5
1/4" BSP	16	15	6	4,5	26,5
3/8" BSP	20	19	7	5,4	33,9
1/2" BSP	24,5	23	8	6	40,5
3/4" BSP	32	30	9	7,5	51,5
1 BSP	38,5	36	11	9	66
M 5	8	7	5,5	3,5	17

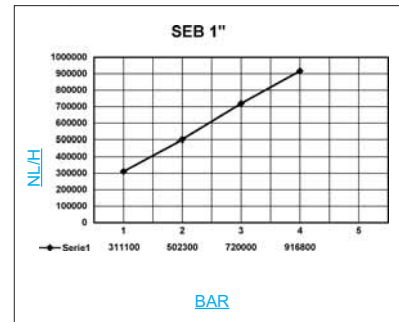
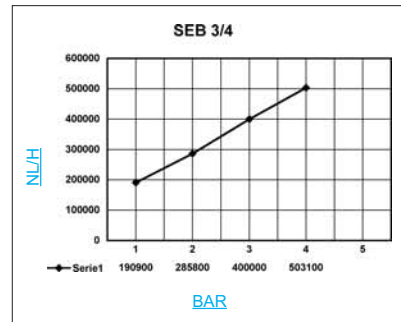
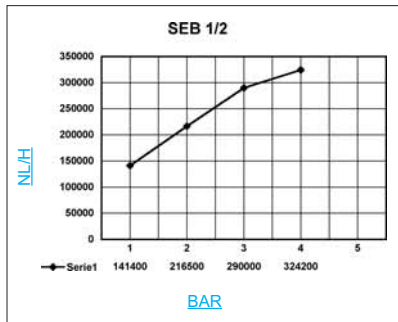
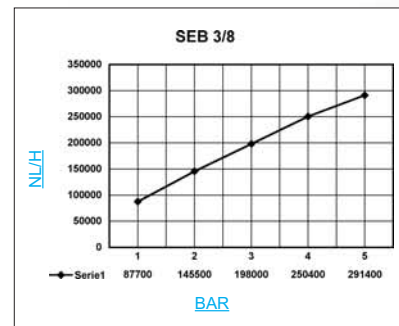
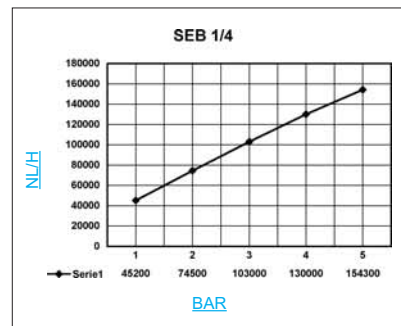
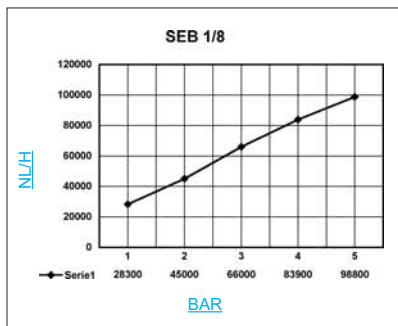

SILENZIATORI
AIR SILENCERS
SILENCIEUX
SCHALLDÄMPFER

COPOR





Livelli di rumore in dB 6 BAR
Noise level at 6 BAR

1/8	1/4	3/8	1/2	3/4	1
80	79	83	85	95	95

Livelli di rumore in dB 4 BAR
Noise level at 4 BAR

1/8	1/4	3/8	1/2	3/4	1
77	76	82	84	91	92

Bronzo sinterizzato
Sintered bronze
Bronze fritte
Sinterbronze

Acciaio ramato
Copper plated
Steel

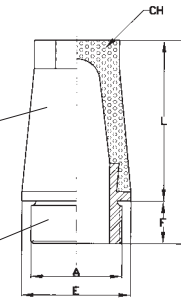

Silenziatore

modello SET

A	E	F	L	H	CH
1/8" BSP	11,5	4,5	17	22	8
1/4" BSP	15	6	22	28	10
3/8" BSP	19	7	29	36	13
1/2" BSP	23	8	35	43	15
3/4" BSP	30	9	46	56	19
1" BSP	37	11	56	67	24
M5	8,5	5	15	20	Ø 7,5

SILENZIATORI
AIR SILENCERS
SILENCIEUX
SCHALLDÄMPFER

COPOR

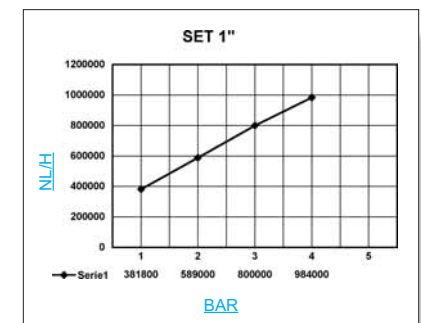
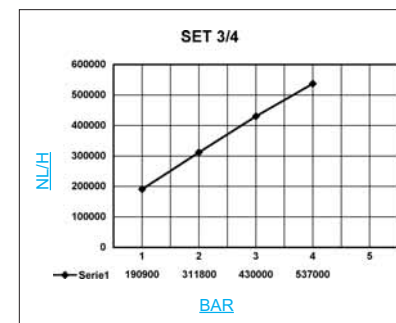
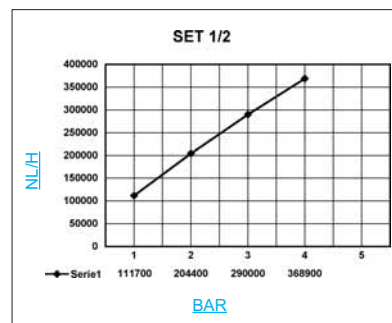
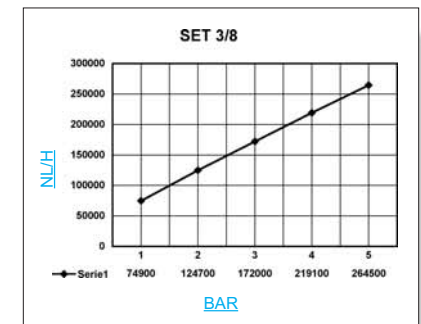
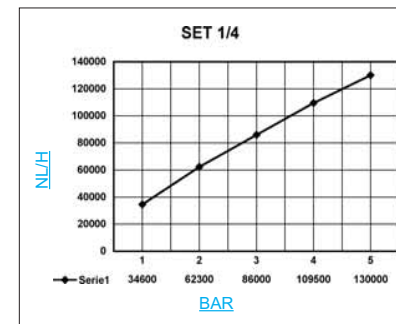
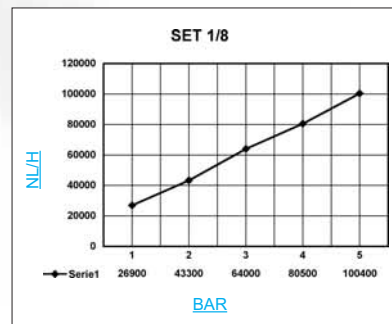

Silenziatore

modello
SC

Livelli di rumore in dB 6 BAR
Noise level at 6 BAR

1/8	1/4	3/8	1/2	3/4	1
70	67	77	80	84	85

Livelli di rumore in dB 4 BAR
Noise level at 4 BAR

1/8	1/4	3/8	1/2	3/4	1
68	65	74	76	80	82

A	E	F	L	H
1/8" BSP	12	6	15	21
1/4" BSP	15	8	19	27
3/8" BSP	19	8	28	36
1/2" BSP	23	10	33	43
3/4" BSP	29	13	40	53
1 BSP	36	15	48	63
M 5	6	4,5	8,5	13
*MAXI 1"1/4" BSP	48	15	65	80
*MAXI 1"1/2" BSP	54	16	77	93
*MAXI 2" BSP	65	17	90	107

*MAXI TYPE is completely in bronze powder

Bronzo sinterizzato nichelato
Sintered bronze nickel plated
Bronze frittè nickel plated
Sinterbronze nickel plated

Ottone nichelato
Brass nickel plated
Laiton nickel plated
Messing nickel plated

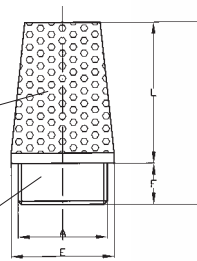

modello SC

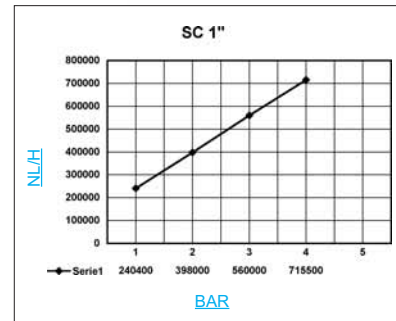
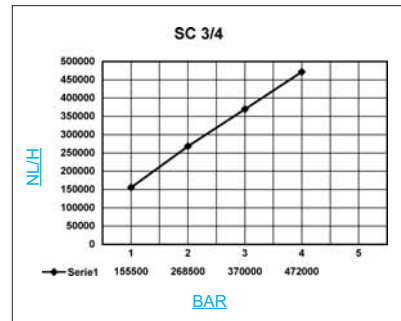
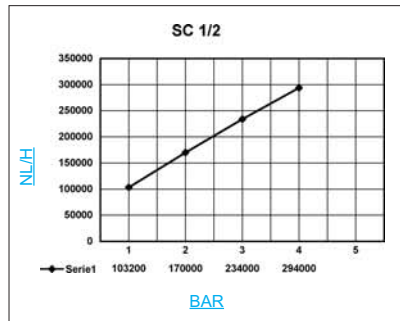
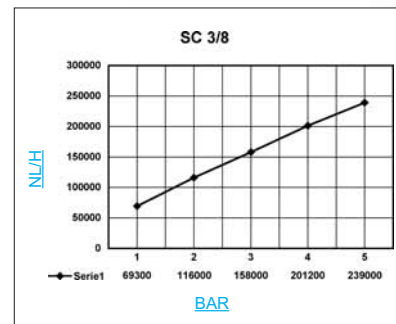
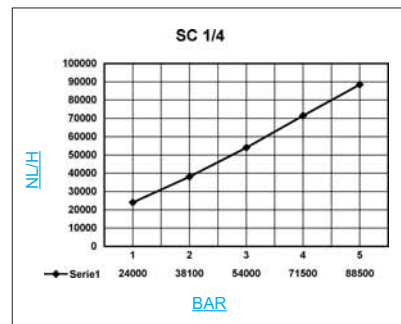
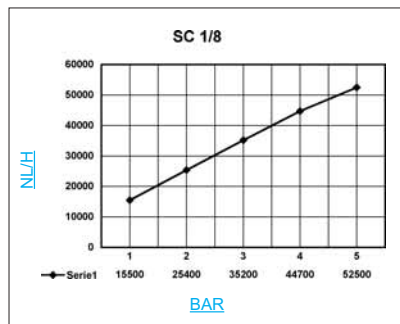

SILENZIATORI
AIR SILENCERS
SILENCIEUX
SCHALLDÄMPFER

COPOR





Livelli di rumore in dB 6 BAR
Noise level at 6 BAR

1/8	1/4	3/8	1/2	3/4	1
70	67	77	80	84	85

Livelli di rumore in dB 4 BAR
Noise level at 4 BAR

1/8	1/4	3/8	1/2	3/4	1
68	65	74	76	80	82

Bronzo sinterizzato
Sintered bronze
Bronze frittè
Sinterbronze

Ottone
Brass
Laiton
Messing

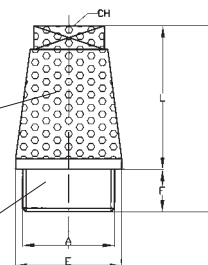

Silenziatore

modello **SCQ**

	A	E	F	L	H	CH
1/8" BSP	12	6	15	21	7	
1/4" BSP	15	8	19	27	8	
3/8" BSP	19	8	28	38	10	
1/2" BSP	23	10	33	43	14	
3/4" BSP	30	13	40	53	17	
1" BSP	36	15	48	63	23	

SILENZIATORI
AIR SILENCERS
SILENCIEUX
SCHALLDÄMPFER

COPOR

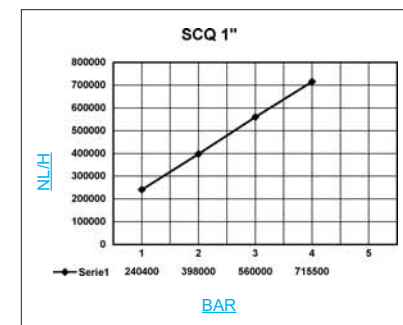
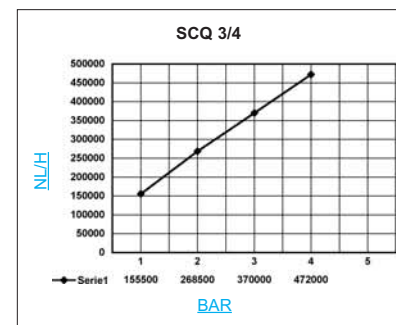
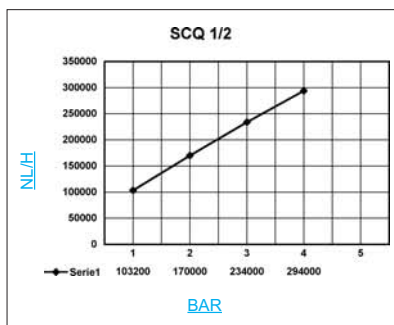
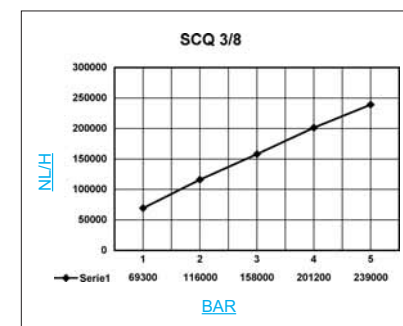
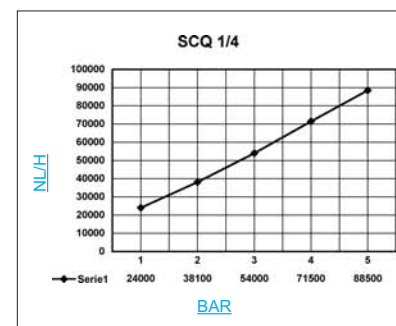
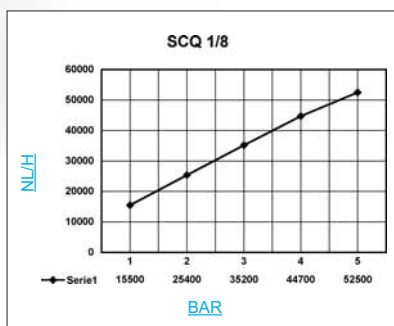

Silenziatore

modello
SCT

Livelli di rumore in dB 6 BAR
Noise level at 6 BAR

1/8	1/4	3/8	1/2	3/4	1
70	67	77	80	84	85

Livelli di rumore in dB 4 BAR
Noise level at 4 BAR

1/8	1/4	3/8	1/2	3/4	1
68	65	74	76	80	82

A	E	F	L	H
1/8" BSP	12	6	15	21
1/4" BSP	15	7	19	26
3/8" BSP	19	8	28	36
1/2" BSP	23	10	33	43
3/4" BSP	30	13	40	53
1" BSP	38	15	48	63

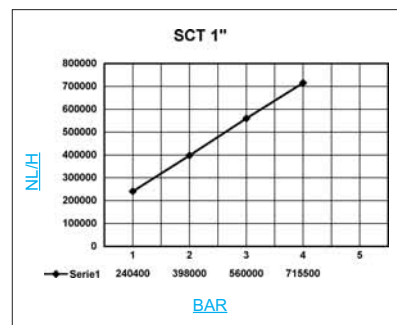
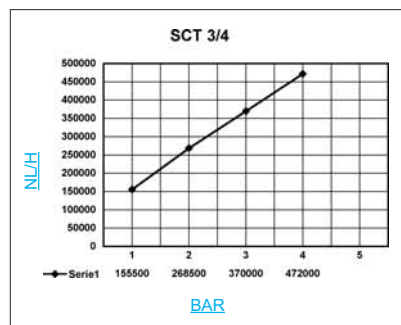
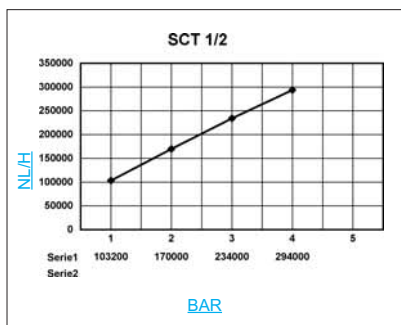
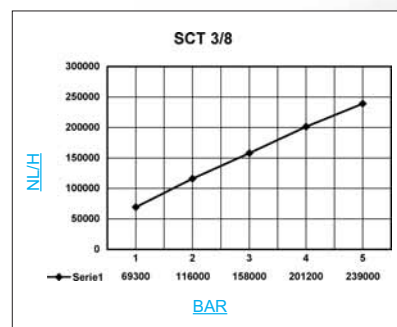
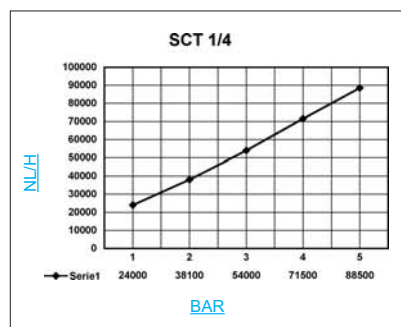
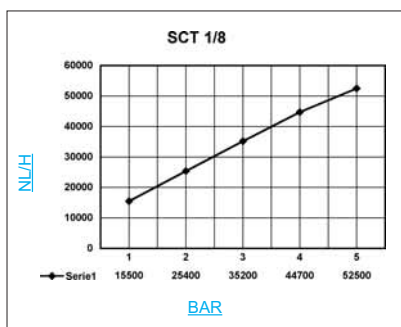
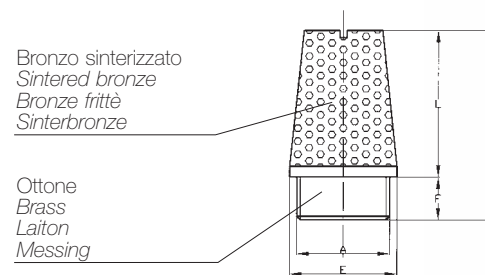

SILENZIATORI
AIR SILENCERS
SILENCIEUX
SCHALLDÄMPFER

COPOR





Livelli di rumore in dB 6 BAR
Noise level at 6 BAR

1/8	1/4	3/8	1/2	3/4	1
72	73	84	88	88	89

Livelli di rumore in dB 4 BAR
Noise level at 4 BAR

1/8	1/4	3/8	1/2	3/4	1
69	70	82	84	85	85

Bronzo sinterizzato
Sintered bronze
Bronze frittè
Sinterbronze

Ottone
Brass
Laiton
Messing

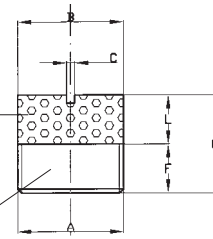

Silenziatore

modello
STT-ST

A	B	F	L	H	C
1/8" BSP	10	6	6	12	1,5
1/4" BSP	13	8	6	14	1,5
3/8" BSP	17	8	8	16	1,5
1/2" BSP	20	12	8	20	2,5
3/4" BSP	26	14	9	23	2,5
1 BSP	33	14	11	25	2,5

SILENZIATORI
AIR SILENCERS
SILENCIEUX
SCHALLDÄMPFER

COPOR

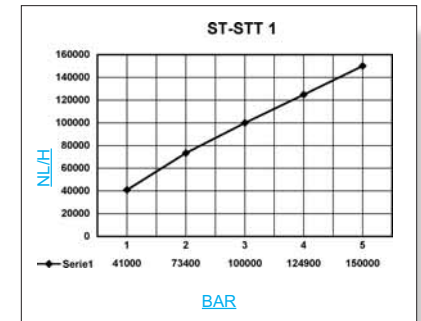
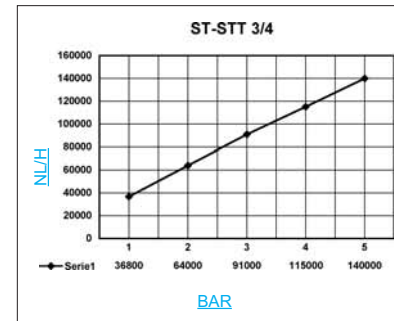
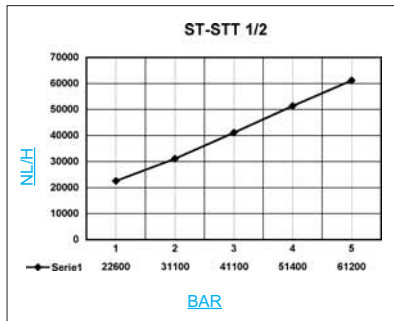
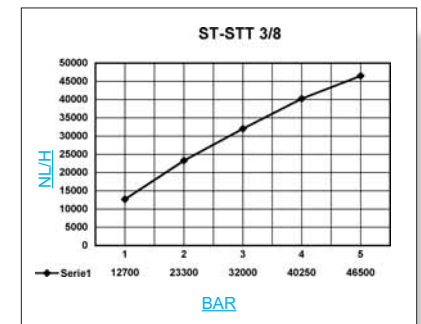
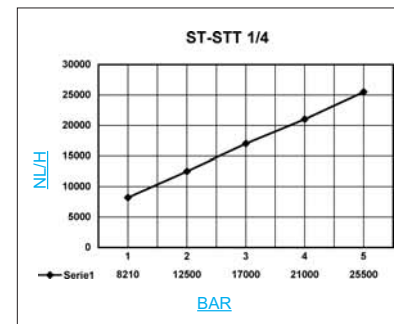
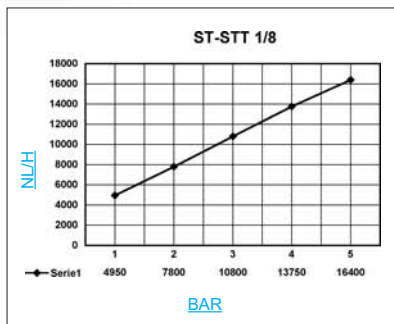

Silenziatore

modello
SBE

Livelli di rumore in dB 6 BAR
Noise level at 6 BAR

1/8	1/4	3/8	1/2	3/4	1
75	81	82	85		

Livelli di rumore in dB 4 BAR
Noise level at 4 BAR

1/8	1/4	3/8	1/2	3/4	1
70	75	78	81	83	84

A	N	F	L	H	CH
1/8" BSP	4	6	17	27	13
1/4" BSP	5	8	19	32	16
3/8" BSP	5	8	27	40	19
1/2" BSP	5	10	32	47	24
3/4" BSP	5	10	38	53	30
1 BSP	6	10	49	65	36
M 5	3	4	11	18	8
1/8" FEM BSP	4	6	16	26	13

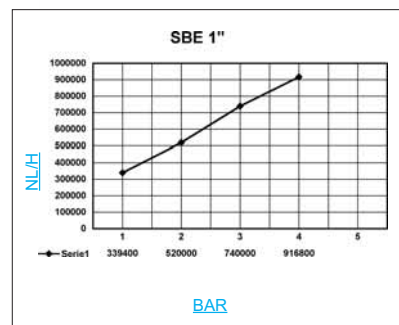
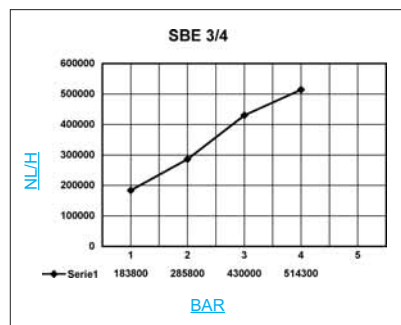
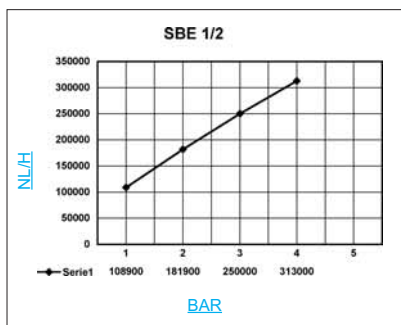
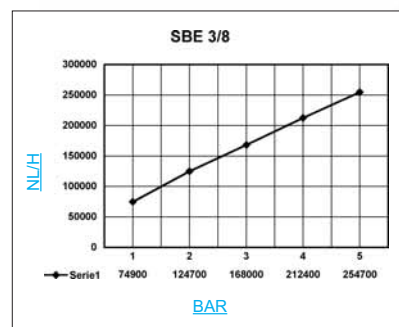
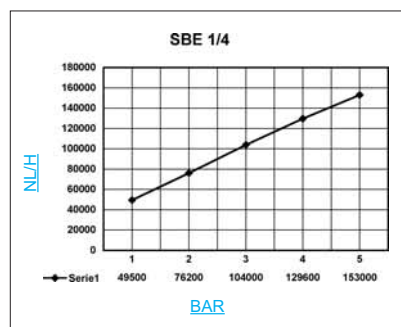
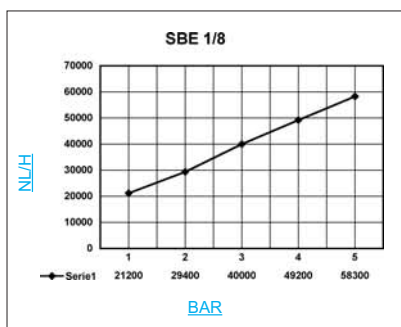
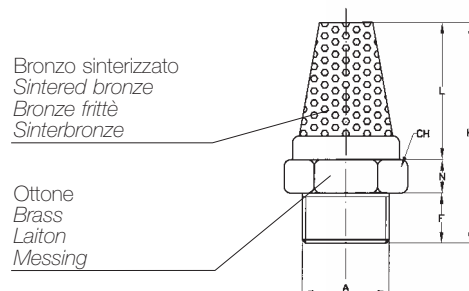

SILENZIATORI
AIR SILENCERS
SILENCIEUX
SCHALLDÄMPFER

COPOR





Livelli di rumore in dB 6 BAR
Noise level at 6 BAR

1/8	1/4	3/8	1/2	3/4	1
76	75	88	89		

Livelli di rumore in dB 4 BAR
Noise level at 4 BAR

1/8	1/4	3/8	1/2	3/4	1
73	73	85	84	82	83

Bronzo sinterizzato
Sintered bronze
Bronze frittè
Sinterbronze

Ottone
Brass
Laiton
Messing

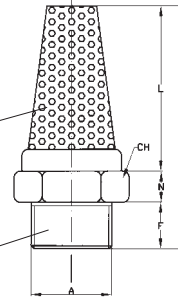

Silenziatore

modello
SAC

A	N	F	L	H	CH
1/8" BSP	4	6	32	42	13
1/4" BSP	5	7	35	47	16
3/8" BSP	5	8	39	52	19
1/2" BSP	5	10	52	67	24
3/4" BSP	5	10	59	74	30
1 BSP	6	10	73	89	36
M5	4	4	18	26	8
1/8" FEM BSP	8	7	30	45	13

SILENZIATORI
AIR SILENCERS
SILENCIEUX
SCHALLDÄMPFER

COPOR

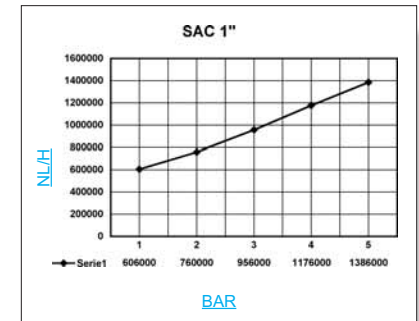
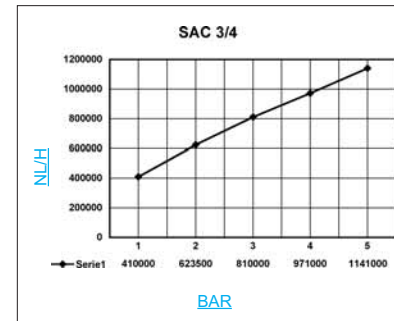
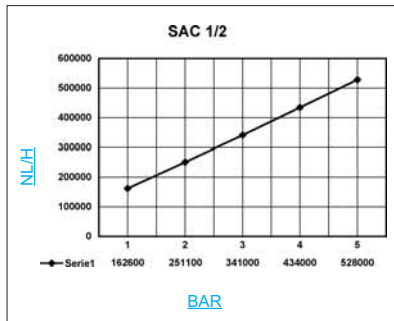
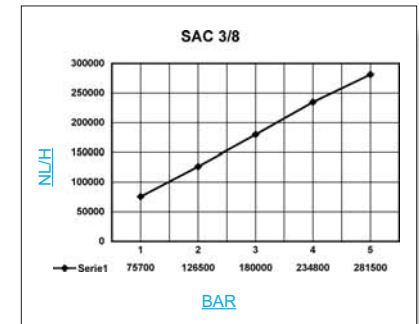
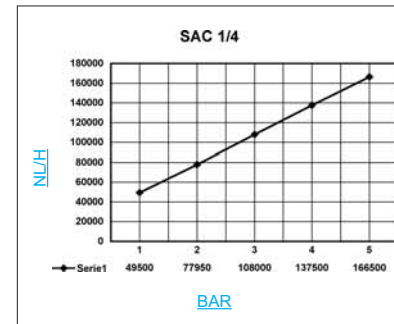
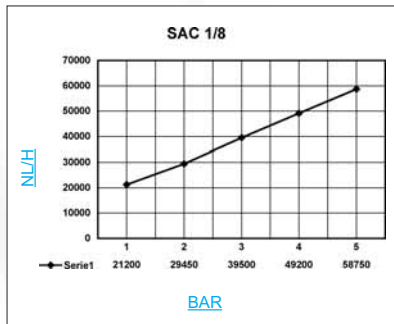

Silenziatore

modello
SBT

Livelli di rumore in dB 6 BAR
Noise level at 6 BAR

1/8	1/4	3/8	1/2	3/4	1
75	81	82	85		

Livelli di rumore in dB 4 BAR
Noise level at 4 BAR

1/8	1/4	3/8	1/2	3/4	1
70	75	78	81	83	84

A	E	F	L	H	N
1/8" BSP	13	6	15	25	4
1/4" BSP	16	7	20	30	3
3/8" BSP	19	8	27	38	3
1/2" BSP	24	10	28	42	4
3/4" BSP	30	10	38	52	4
1" BSP	38	12	46	65,5	7,5
M5	13	5	15	24	4
1/8" FEM BSP	12	7	15	26	4

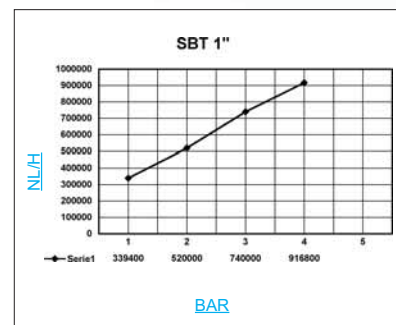
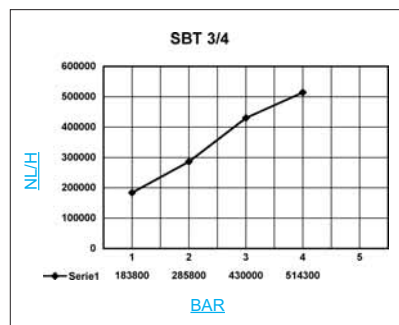
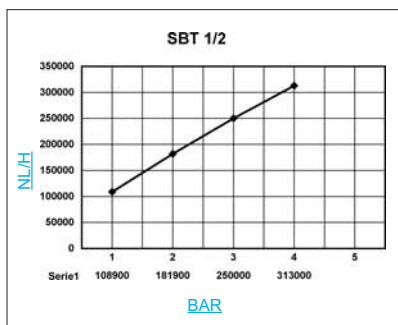
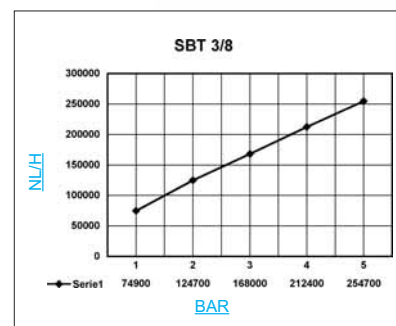
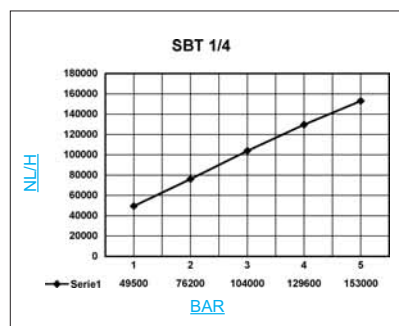
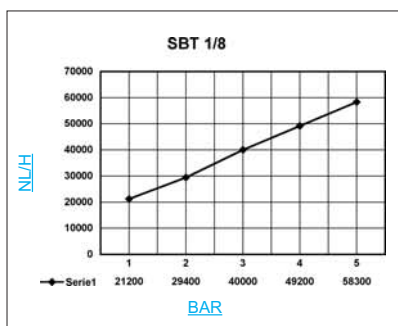
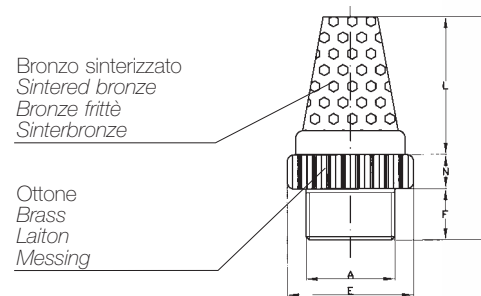

SILENZIATORI
AIR SILENCERS
SILENCIEUX
SCHALLDÄMPFER

COPOR





Livelli di rumore in dB 6 BAR
Noise level at 6 BAR

1/8	1/4	3/8	1/2	3/4	1
75	81	82	85		

Livelli di rumore in dB 4 BAR
Noise level at 4 BAR

1/8	1/4	3/8	1/2	3/4	1
70	75	78	81	83	84

Bronzo sinterizzato
Sintered bronze
Bronze frittè
Sinterbronze

Ottone
Brass
Laiton
Messing

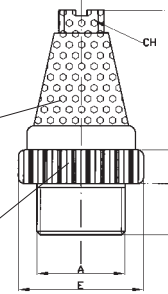

Silenziatore

modello
SBT-T

A	E	F	L	N	CH
1/8" BSP	13	6	15	4	6
1/4" BSP	16	7	20	3	7
3/8" BSP	19	8	27	3	10
1/2" BSP	24	10	28	4	13
3/4" BSP	30	10	38	4	17
1 BSP	38	12	46	7,5	22

SILENZIATORI
AIR SILENCERS
SILENCIEUX
SCHALLDÄMPFER

COPOR

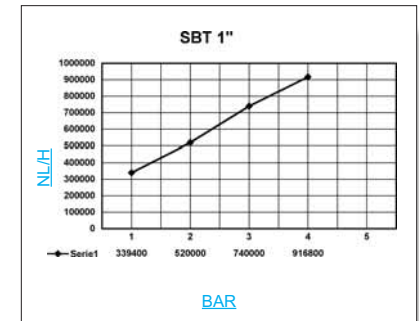
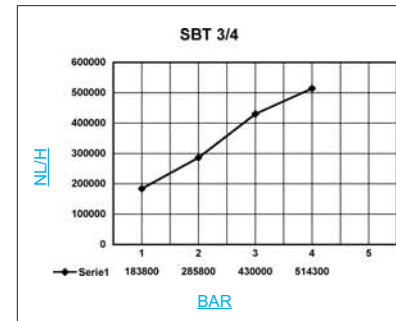
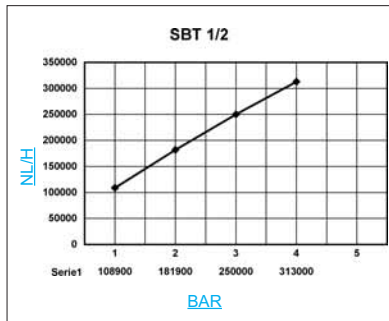
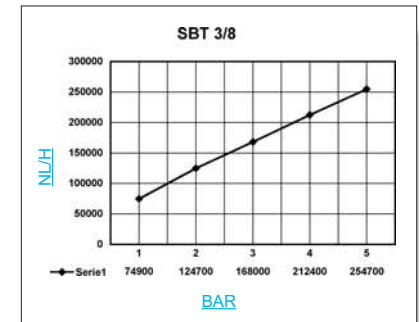
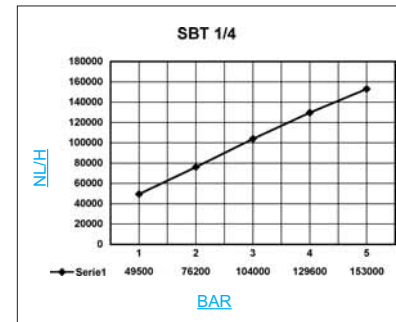
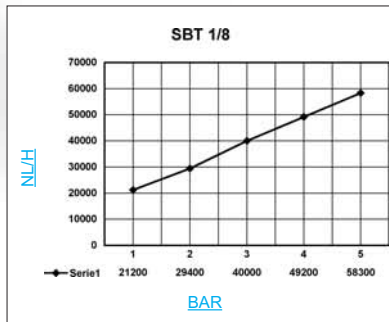

Silenziatore

modello
SPL

Livelli di rumore in dB 6 BAR
Noise level at 6 BAR

1/8	1/4	3/8	1/2	3/4	1
87	84	90	90	91	90

Livelli di rumore in dB 4 BAR
Noise level at 4 BAR

1/8	1/4	3/8	1/2	3/4	1
84	81	83	83	85	85

A	B	F	L	H
1/8" BSP	15	6	26,5	32,5
1/4" BSP	19,5	8	35	43
3/8" BSP	24,5	11	47	58
1/2" BSP	24,5	11	47	58
3/4" BSP	48	18	97	115
1 BSP	48	18	97	115
1/8" FEMBSP	15	6	26,5	32,5

Resina acetilica
Acetalic resin
Resine acetalique
Acetal - harz

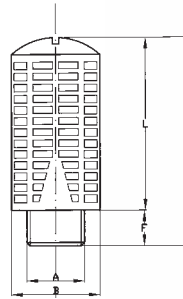

Pressione massima consigliata 6 BAR
We advice a maximum pressure of 6 BAR

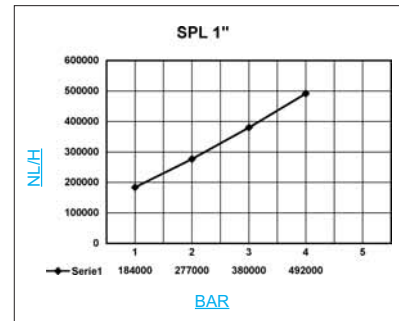
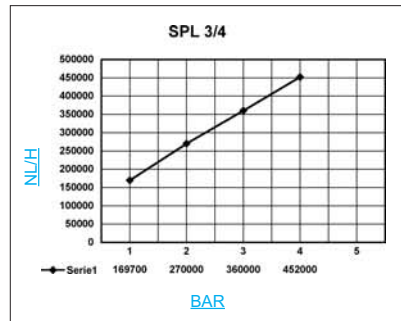
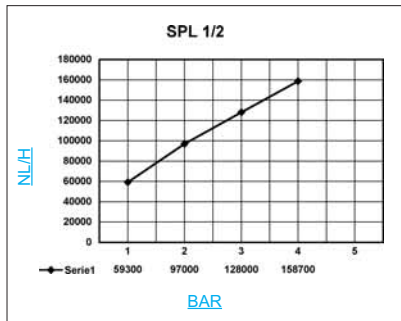
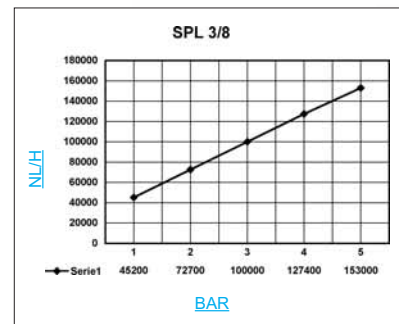
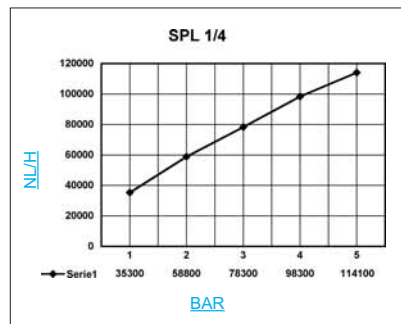
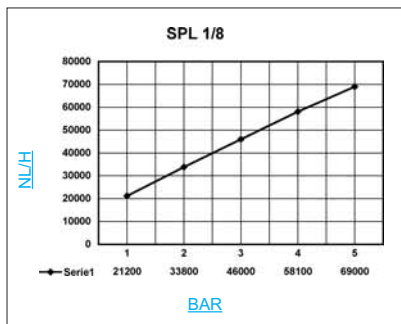

SILENZIATORI
AIR SILENCERS
SILENCIEUX
SCHALLDÄMPFER

COPOR





Livelli di rumore in dB 6 BAR
Noise level at 6 BAR

1/8	1/4	3/8	1/2	3/4	1
87	90	92	92		

Livelli di rumore in dB 4 BAR
Noise level at 4 BAR

1/8	1/4	3/8	1/2	3/4	1
85	86	87	87	88	88

Resina acetica
Acetatic resin
Resine acetaliqne
Acetal - harz

Felt inside

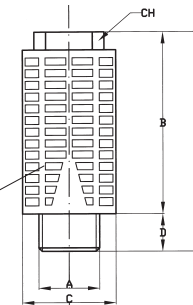

Silenziatore

modello
SPL-F

A	B	C	D	E	CH
1/8" BSP	28	16	6	34	10
1/4" BSP	36	19	8	44	12
3/8" BSP	47	24	10	56	16
1/2" BSP	47	24	10	56	16

A richiesta con filtro in plastica porosa
On request with a porous plastic filter

SILENZIATORI
AIR SILENCERS
SILENCIEUX
SCHALLDÄMPFER

COPOR

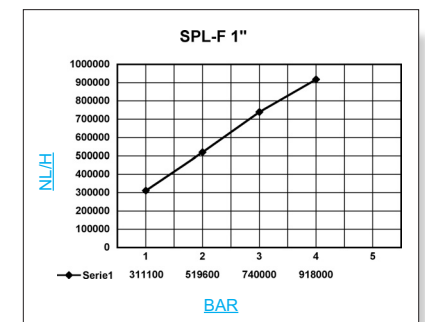
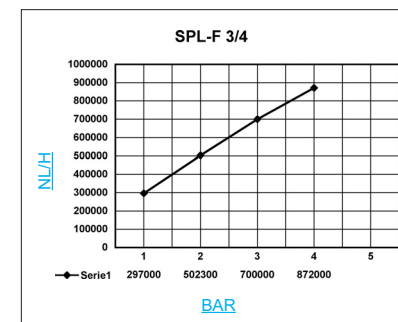
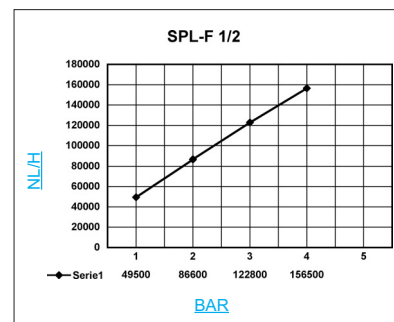
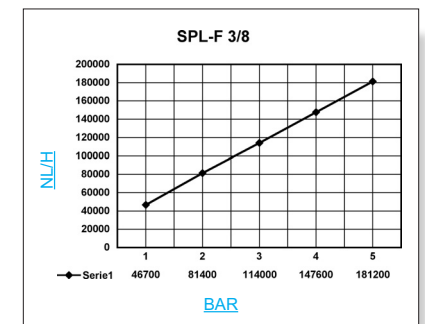
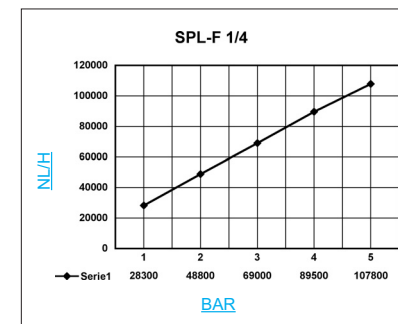
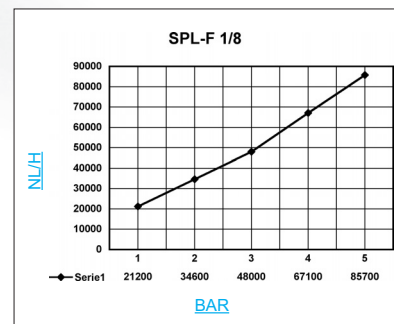

Silenziatore

modello
SVE

Livelli di rumore in dB 6 BAR
Noise level at 6 BAR

1/8	1/4	3/8	1/2	3/4	1
72	73	84	88	88	89

Livelli di rumore in dB 4 BAR
Noise level at 4 BAR

1/8	1/4	3/8	1/2	3/4	1
69	70	82	84	85	85

A	MIN B	MAX B	C	CH
1/8" BSP	20	22	6	13
1/4" BSP	22	24	8	15
3/8" BSP	25	28	10	22
1/2" BSP	26	29	11	22
3/4" BSP	32	37	12	30
1 BSP	32	37	12	36

A richiesta con filtro in filo inox
On request with a Stainless steel filter

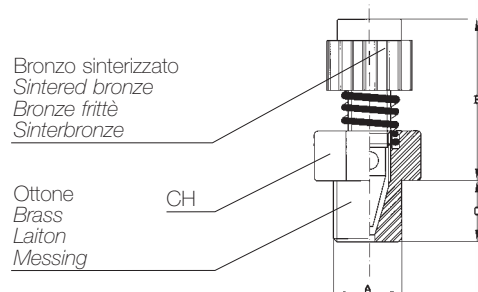

modello **SVE**

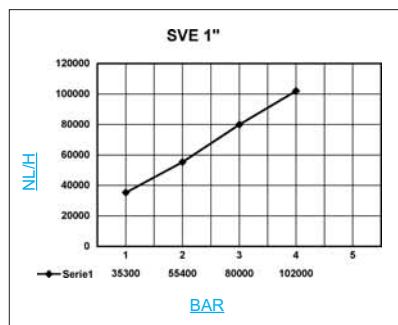
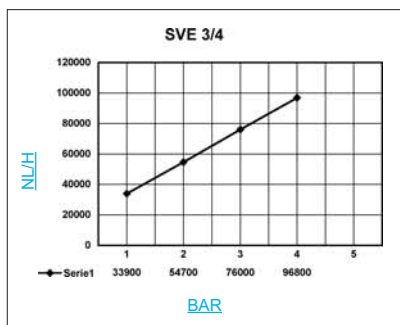
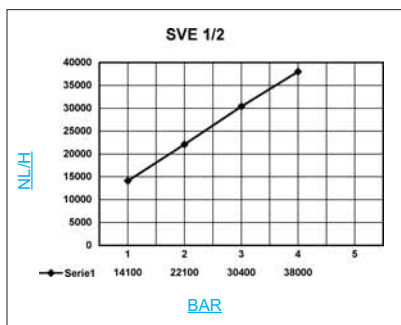
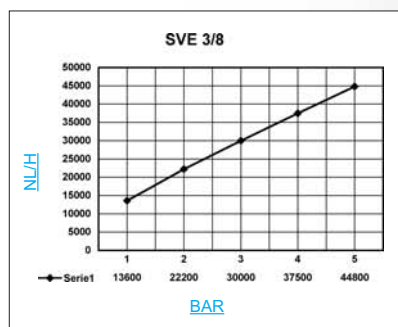
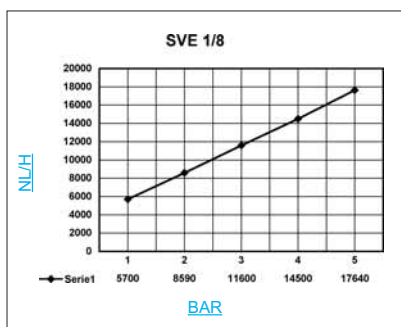

SILENZIATORI
AIR SILENCERS
SILENCIEUX
SCHALLDÄMPFER

COPOR





Livelli di rumore in dB 6 BAR
Noise level at 6 BAR

1/8	1/4	3/8	1/2		
72	73	84	88		

Livelli di rumore in dB 4 BAR
Noise level at 4 BAR

1/8	1/4	3/8	1/2		
69	70	82	84		

Bronzo sinterizzato
Sintered bronze
Bronze frittè
Sinterbronze

Ottone
Brass
Laiton
Messing

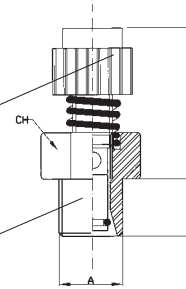

Silenziatore

modello
RBP

A	MIN B	MAX	F	CH
1/8" BSP	14	19	6	12
1/4" BSP	17	22	8	15
3/8" BSP	18	24	9	22
1/2" BSP	18	24	10,5	22

A richiesta con filtro in filo inox
On request with a Stainless steel filter

SILENZIATORI
AIR SILENCERS
SILENCIEUX
SCHALLDÄMPFER

COPOR

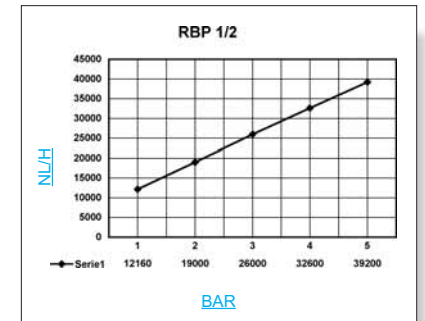
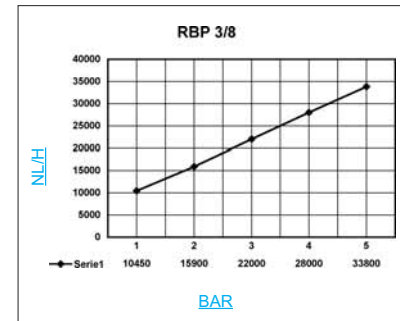
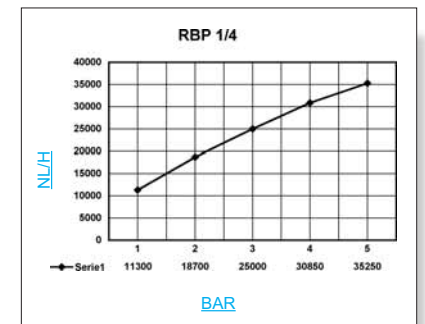
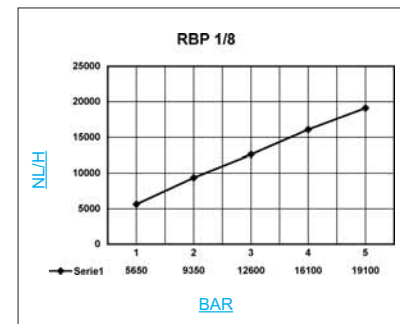

Silenziatore

modello
SVL

Livelli di rumore in dB 6 BAR
Noise level at 6 BAR

1/8	1/4	3/8	1/2	3/4	1
70	72	82	85	85	86

Livelli di rumore in dB 4 BAR
Noise level at 4 BAR

1/8	1/4	3/8	1/2	3/4	1
68	69	80	82	82	83

A	F	L _{MIN}	L _{MAX}	H _{MIN}	H _{MAX}	CH ₁	CH ₂
1/8" BSP	8	30	36	38	44	10	16
1/4" BSP	9	30	36	39	45	10	16
3/8" BSP	10	37	50	47	60	10	22
1/2" BSP	11	37	50	48	61	10	22
3/4" BSP	11	56	80	98	92	13	30
1" BSP	11	56	80	68	92	13	36
M5	3,5	13	18	16	21	6	8

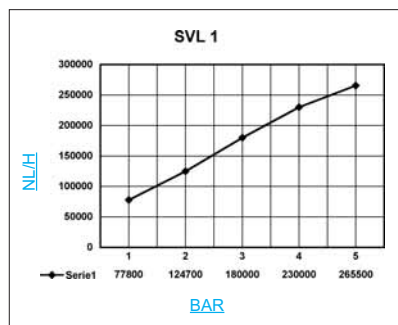
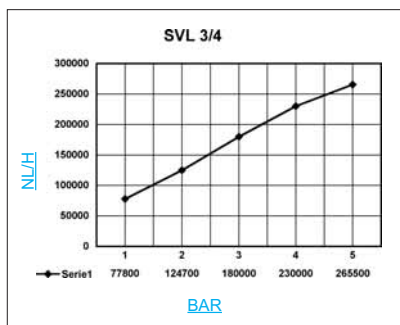
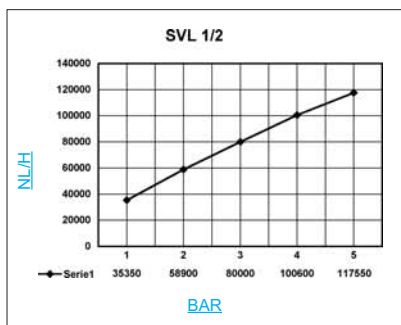
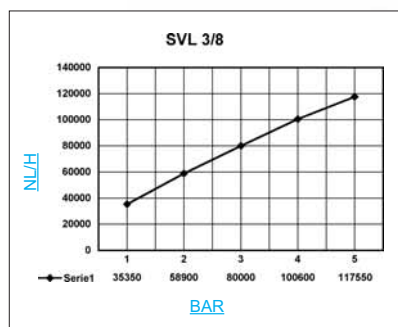
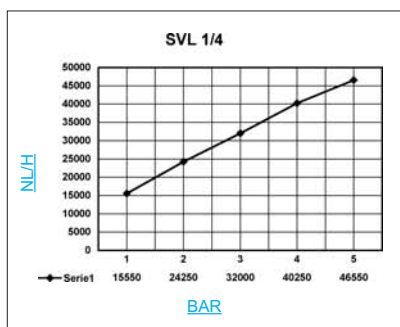
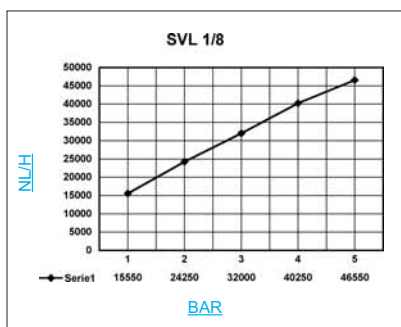
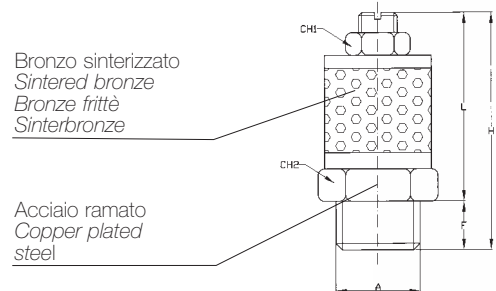

SILENZIATORI
AIR SILENCERS
SILENCIEUX
SCHALLDÄMPFER

COPOR





Livelli di rumore in dB 6 BAR
Noise level at 6 BAR

1/8	1/4	3/8	1/2	3/4	1
75	77	80	80		

Livelli di rumore in dB 4 BAR
Noise level at 4 BAR

1/8	1/4	3/8	1/2	3/4	1
72	72	74	75		

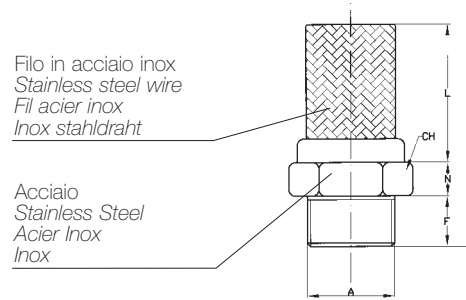

Silenziatore

modello **SBEX**

A	N	F	L	H	CH
1/8" BSP	8	6	15	29	13
1/4" BSP	8	7	17	32	16
3/8" BSP	7	8	25	40	19
1/2" BSP	9	9	27	45	24

SILENZIATORI
AIR SILENCERS
SILENCIEUX
SCHALLDÄMPFER

COPOR

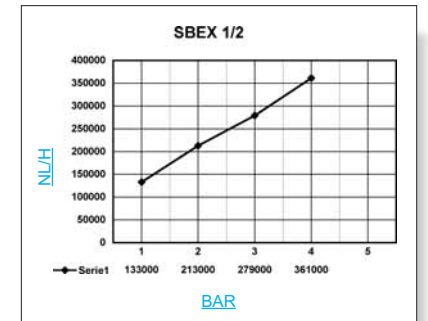
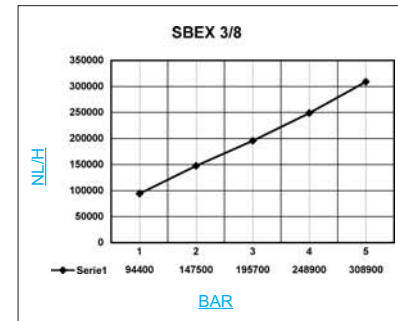
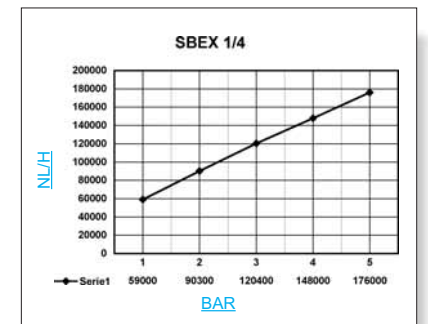
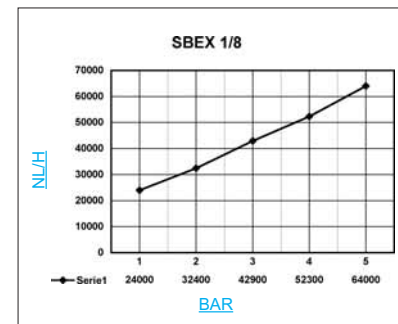

Silenziatore

modello
EP-METALLIC

Livelli di rumore in dB 6 BAR
Noise level at 6 BAR

1/8	1/4	3/8	1/2	3/4	1
83	83	83	84	84	81

Livelli di rumore in dB 4 BAR
Noise level at 4 BAR

1/8	1/4	3/8	1/2	3/4	1
77	77	77	79	79	80

A	B	C	D	E
1/8" BSP	49	80	70	10
1/4" BSP	49	106	93	13
3/8" BSP	70	126	113	16
1/2" BSP	86	146	132	13
3/4" BSP	89	179	162	17
1 BSP	103	219	192	26
1"1/4" BSP	103	219	192	26
1"1/2" BSP	136	351	318	33
2 BSP	136	484	450	33

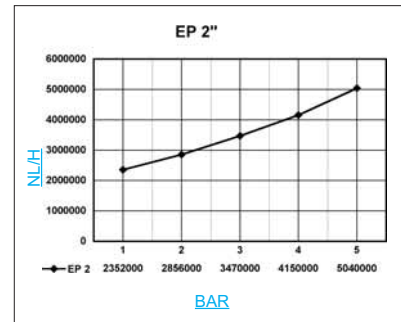
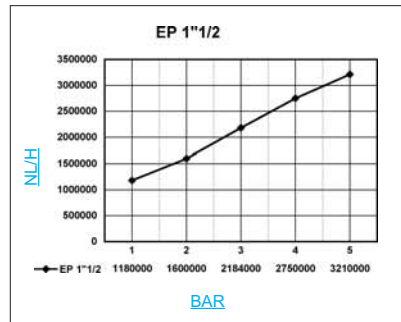
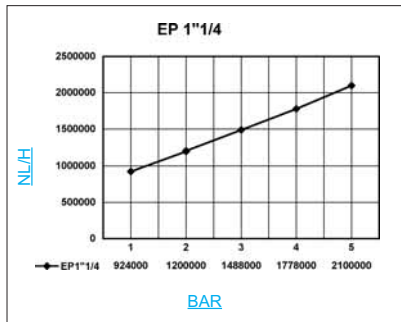
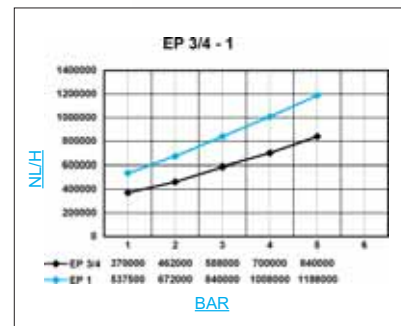
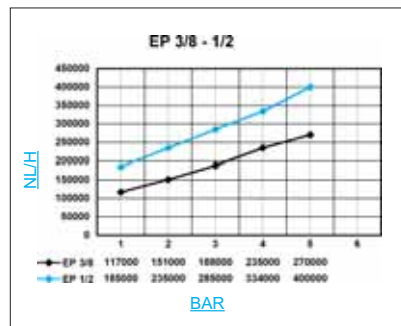
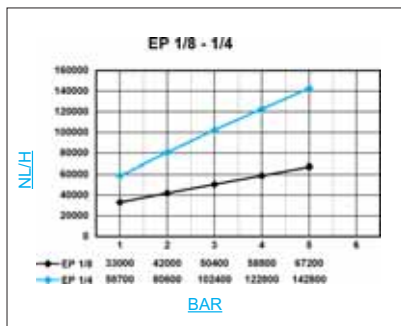
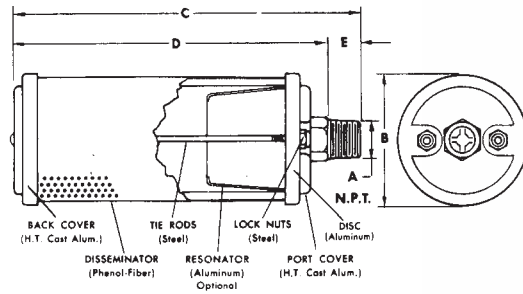

SILENZIATORI
AIR SILENCERS
SILENCIEUX
SCHALLDÄMPFER

COPOR

